

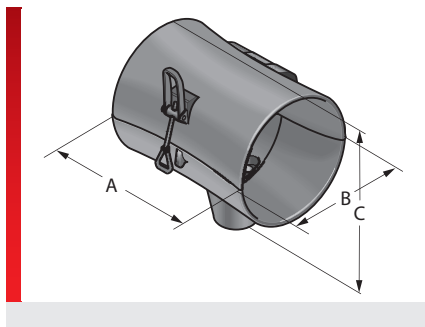



Trumpet





PRODUCT INFORMATION

Trumpet for sliding guidance and spring return of jumbo-sized dresspacks. The TRO-70 is detachably connected, made of durable plastic, and is latched with safety clips.

SPECIFICATIONS

-  Mod. polyamide PA 6
-  -40 – 110 °C
-  V0

 HF
 RoHS
 Made in Germany

Type	Order No.	Colour	Suitable for Murrflex	A mm	B mm	C mm	Pack qty.
TRO 70	83692004	Black	NW70	119.00	121.00	148.00	1

Suitable for

 Mod. polyamide PA 6

THERMAL PROPERTIES

 **Temperature / temperature range**
-40 – 110 °C

FIRE BEHAVIOUR

 **Fire classification**
V0

APPROVALS AND OPERATING PERMITS

 **ROBI approval**

TECHNICAL INFORMATION

 **Halogen-free**

CONFORMITY

 **RoHS (EC Directive 202/95/EC)**

Trumpet

GENERAL INFORMATION



Made in Germany

All details given in our sales material prospectuses and catalogues as well as the information available online are based on our current knowledge of the products described.

The electronic data and files made available by Murrplastik, particularly CAD files are based on our current knowledge of the product described.

A legally binding assurance of certain properties or the suitability for a certain purpose can not be determined from this information.

All information with respect to the chemical and physical properties of Murrplastik products as well as application advice given verbally, in writing or by tests, is given to the best of our knowledge.

This does not free the purchaser of carrying out their own inspections and tests in order to determine the suitability of a product for a specific purpose.

Murrplastik accepts no responsibility for the available information being up-to-date, correct or complete. Neither do we accept responsibility for the quality of this information.

Murrplastik accepts no liability for damage caused as a result of using our products.

Murrplastik reserves the right to make technical changes and improvements through constant further development of products and services.

Our General Terms and Conditions apply.

© Murrplastik Systemtechnik GmbH • privID_96587~20170911~890283~83692004